

Top

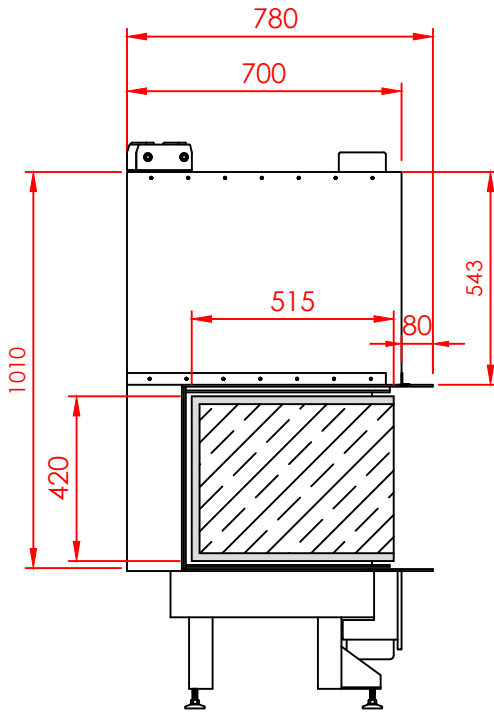

Side

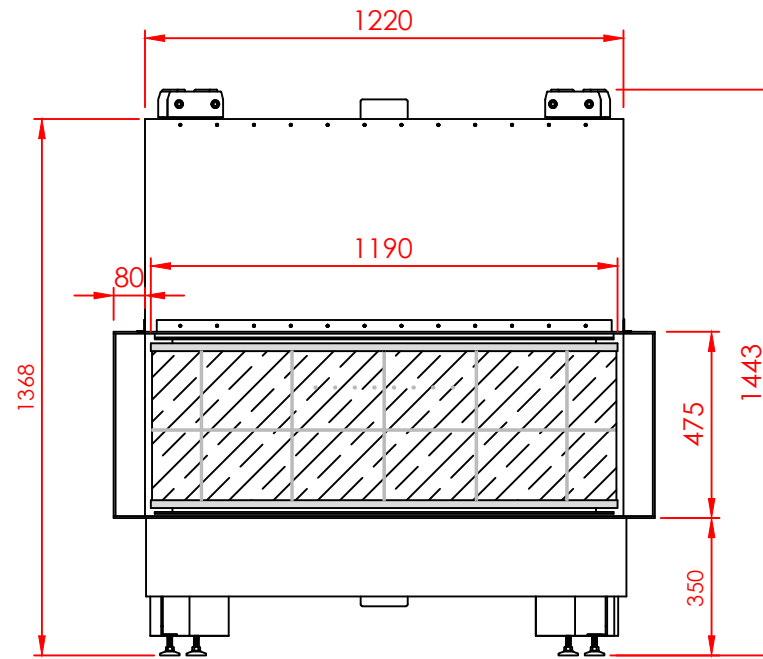

Front

Series:	Pi
Model:	Architectural
Type:	119x42
Specials:	STD

All dimensions in mm
 General dimension tolerances up to 7mm
 All illustrations and drawings are protected by copyright.
 Exploitation or publication, even of individual details,
 only with our permission.
 Technical changes and errors reserved.



Nea Redestos, Themi, 57001
 Thessaloniki GREECE
 t: +30 2310 461386 f: +30 2310 461493
 e: info@regal.com.gr
 www.tzakiaregal.gr | www.regal.com.gr

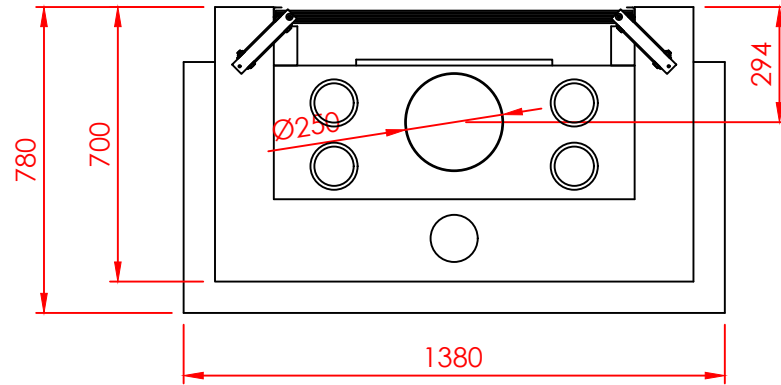

Top

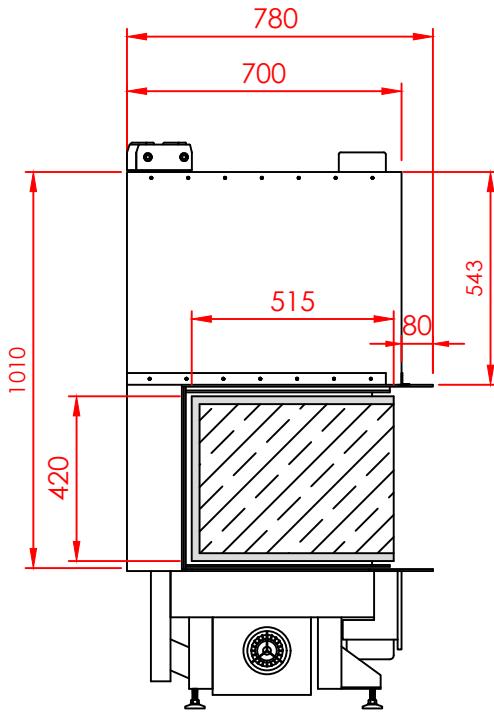

Side

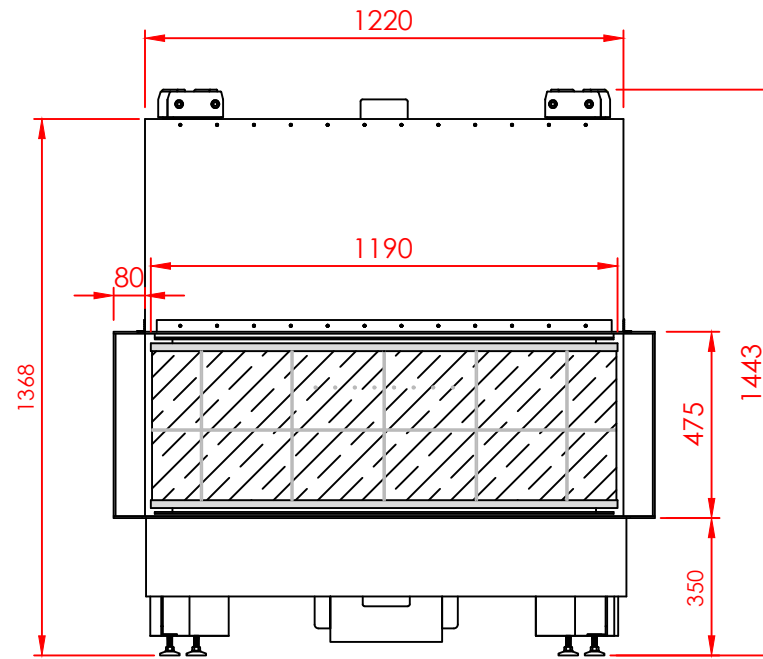

Front

Series:	Pi
Model:	Architectural
Type:	119x42
Specials:	AERO

All dimensions in mm
 General dimension tolerances up to 7mm
 All illustrations and drawings are protected by copyright.
 Exploitation or publication, even of individual details,
 only with our permission.
 Technical changes and errors reserved.



Nea Redestos, Themi, 57001
 Thessaloniki GREECE
 t: +30 2310 461386 f: +30 2310 461493
 e: info@regal.com.gr
 www.tzakiaregal.gr | www.regal.com.gr